

COMPLIANCE	ANSI/EIA RS-310D
	IEC60297-2
	DIN41494; Part 1
	DIN41494; Part 7

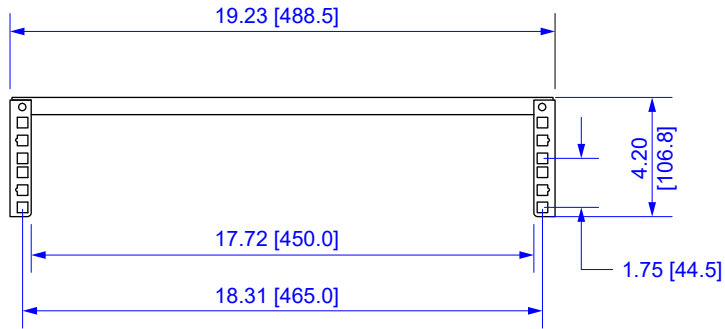

TOP

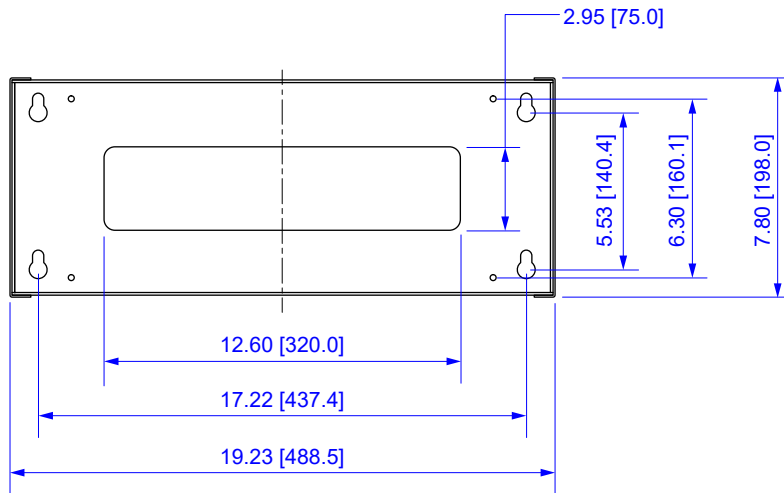
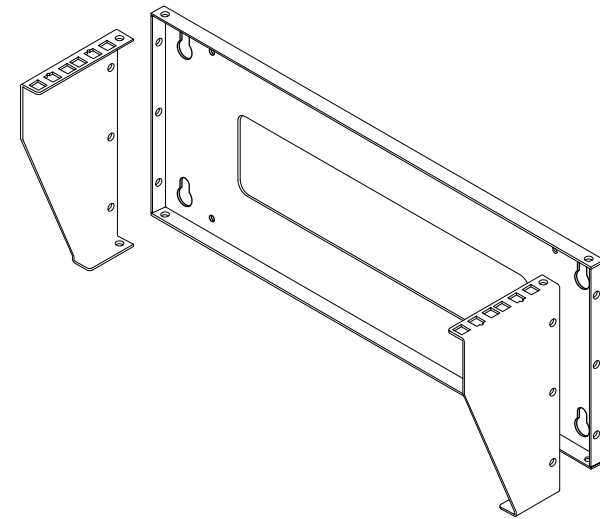

FRONT



SIDE

No.	Description	Gauge	Qty
1	Back Plate	14	1
2	Side Bracket	14	2
3	M6 x 12mm Screws	N/A	20
4	M6 Flange Nuts	N/A	10
5	M6 Cage Nuts	N/A	10

ITEM NO.		VB2-021		
DESCRIPTION				
2U VERTICAL WALL MOUNT BRACKET				
DATE	SCALE	SHEET	REV	
02/04/2020	none	1 of 1		

All dimensions in inches [millimeters]