

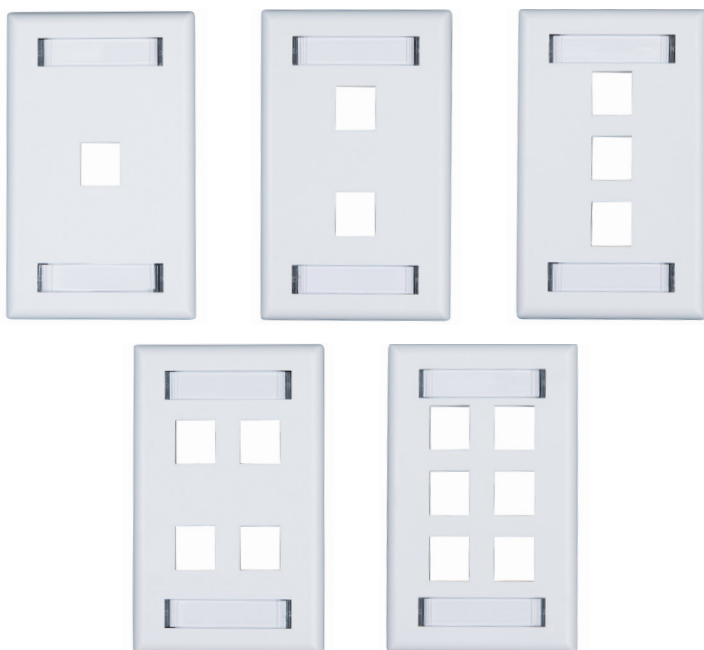

Keystone Faceplates



Description / Specifications

Vericom standard keystone faceplates with labels are available in 1, 2, 3, 4, or 6 port and are ideal for use with any standard keystone modules to create an individualized plug and play multimedia experience. These faceplates are constructed of impact resistant, fire-retardant UL94V-0 rated plastic. These White faceplates come complete with mounting screws, label and plastic label cover.

Features & Benefits

- Compatible with standard keystone modules for a variety of applications
- Flush mounting for an aesthetic look
- Offered in 1, 2, 3, 4, or 6 port for versatility
- Includes label, label cover, and screws for mounting
- Available in White to match any décor

Applications

These standard single gang faceplates provide labels and accept snap-in modules to support multimedia applications in situations requiring a flush mount and TIA-606 labeling.

Ordering Information

PART NUMBER	DESCRIPTION
FP2WH1VL	SINGLE GANG 1 PORT WHITE KEYSTONE FACEPLATE W/ LABELS
FP2WH2VL	SINGLE GANG 2 PORT WHITE KEYSTONE FACEPLATE W/ LABELS
FP2WH3VL	SINGLE GANG 3 PORT WHITE KEYSTONE FACEPLATE W/ LABELS
FP2WH4VL	SINGLE GANG 4 PORT WHITE KEYSTONE FACEPLATE W/ LABELS
FP2WH6VL	SINGLE GANG 6 PORT WHITE KEYSTONE FACEPLATE W/ LABELS



Keystone Faceplates

Technical Drawing

1 Port

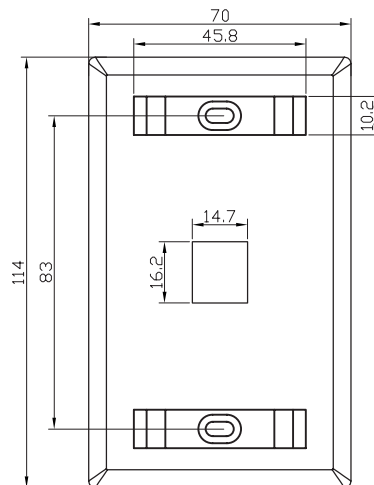
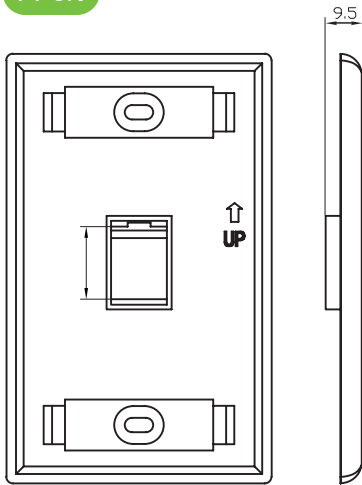

2 Port

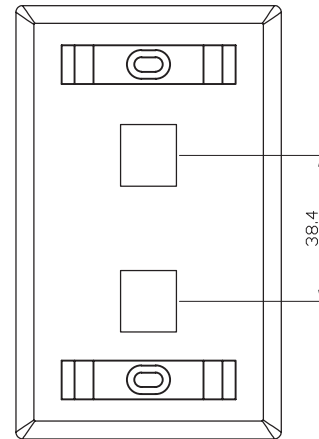

3 Port

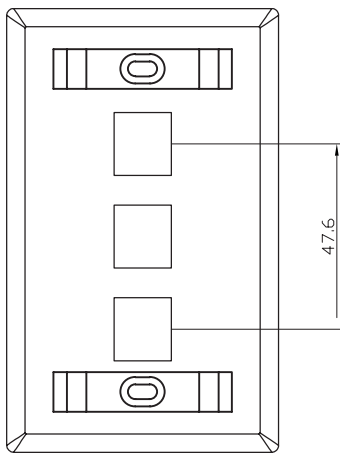

4 Port

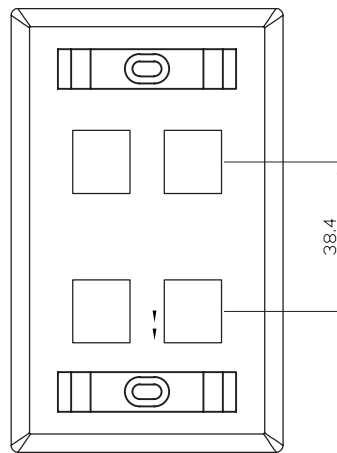

6 Port

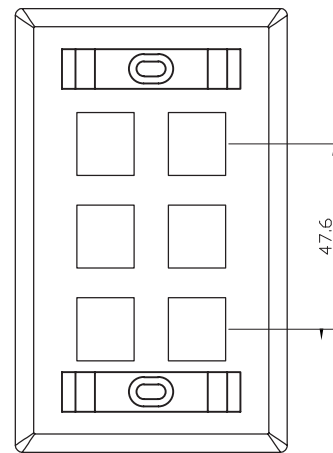

Physical Specifications

# of Ports	1 Port	2 Port	3 Port	4 Port	6 Port
Dimensions	114*70*9.5 mm	114*70*9.5 mm	114*70*9.5 mm	114*70*9.5 mm	114*70*9.5 mm
Material	High Impact, Fire retardant ABS plastic rated UL94V-0				
Mounting	Screws (Included)				
Color	White				

TECHNICAL SHEETS ARE SUBJECT TO CHANGE WITHOUT NOTICE.

REV.20200810.1